

Varenummer: 20141V20B202SW  
 Beskrivelse: E+G Kryds m/flange  
 GN141-V20-B20-2-SW

## Mål

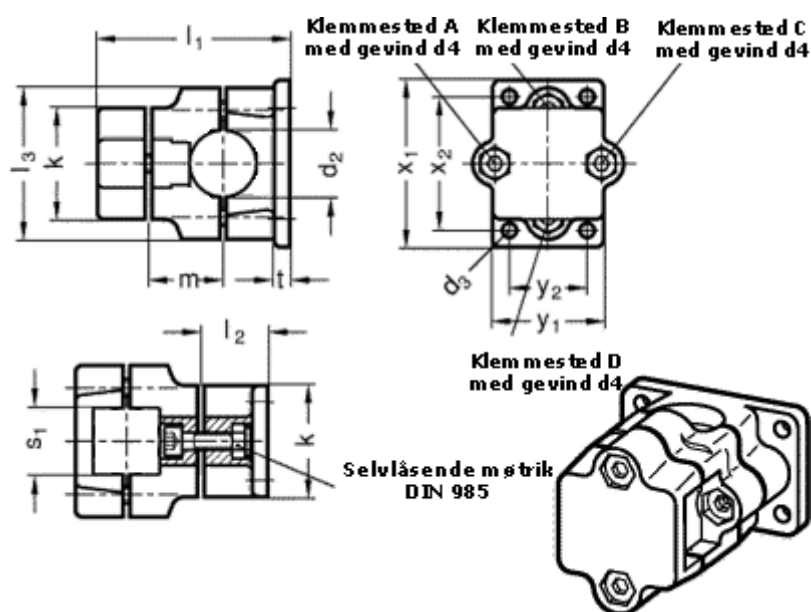

$d_2 = 20$	$s_1 = 20$
$d_3 = 7$	$t = 7$
$d_4 = M 8$	Vippehåndtag = GN 911-M 8-35 skal bestilles separat
$k = 50$	$x_1 = 75$
$l_1 = 89$	$x_2 = 60$
$l_2 = 30$	$y_1 = 50$
$l_3 = 68$	$y_2 = 35$
$m = 36$	